



POSTAL SERVICE
STUDY GUIDE

**Postal Service
Practice Exam
Sample Exam # 5
Exam # 955E**

Copyright 2022 All rights reserved
Customer Support: support@PostalJobsSourcepmp.com

About Exam 955E

This exam is only used for a few positions, primarily maintenance jobs such as Building Equipment Mechanic, Maintenance Mechanic, Electronic Technician and Mail Processing Equipment Mechanic. Although this exam only covers a fairly small number of positions, this maintenance field in general is expected to have strong job growth into the future. The primary reason for this is automation. With the ever increasing automation of the Postal Service operations, there are more machines and equipment that will need attention. If you have an interest or background in maintenance, it would also be beneficial to check out books at your local library on various maintenance tasks.

Exam 955E has two separate sections.

The first section is the Personal Characteristics & Experience Inventory section (known as PCEI or PCI). Because this section is a part of multiple exams, we went over this section in the “Postal Service and Other Government Job Opportunities Guide”. The Guide was available for download separately, when you downloaded this practice exam. If you did not download the Guide when you downloaded this practice exam, you can simply refer back to the email we sent you for the download link to access the “Postal Service and Other Government Job Opportunities Guide ”.

The second section contains the majority of the exam. A sample of that section of the exam begins on the next page.

Sample EXAM # 5 Part I

1. The semi-conductor materials contained in a transistor are designated by the letter(s)
- A) N, P
 - B) Q, R
 - C) AP
 - D) MNP
 - E) none of the above

Figure 5-1

2. What measuring device is illustrated in figure 5-1?
- A) radial calipers
 - B) outside calipers
 - C) micrometer
 - D) inside calipers
 - E) pitch gage

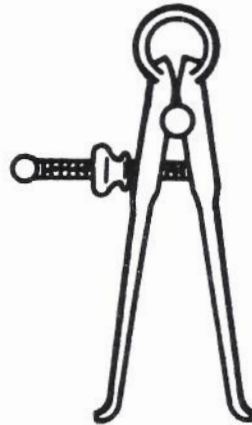

3. Which of the following circuits or devices always has inductance?
- A) distributor
 - B) coil
 - C) condenser
 - D) point
 - E) filter
4. Lead anchors are usually mounted in what?
- A) drywall
 - B) sheet metal
 - C) masonry
 - D) wood
 - E) none of the above

5. One characteristic of the breast drill is that it

- A) is hand operated
- B) contains no gears
- C) has 4 speeds
- D) has a 4 hp motor
- E) is steam powered

6. A screw pitch gage can be used for

- A) checking the thread angle
- B) measuring the screw threads
- C) measuring the number of gages available
- D) cleaning the threads
- E) determining the pitch and number of internal threads

7. A change from refrigerant vapor to liquid while the temperature stays constant results in a

- A) sensible pressure loss
- B) latent pressure loss
- C) super heat loss
- D) latent heat loss
- E) super pressure loss

8. The device pictured in Figure 5-2 is in a rest position. Which position, if any, is the normal closed?

- A) C
- B) A
- C) B
- D) the normal closed is not shown in this diagram
- E) devices of this sort have no normal closed position

Figure 5-2

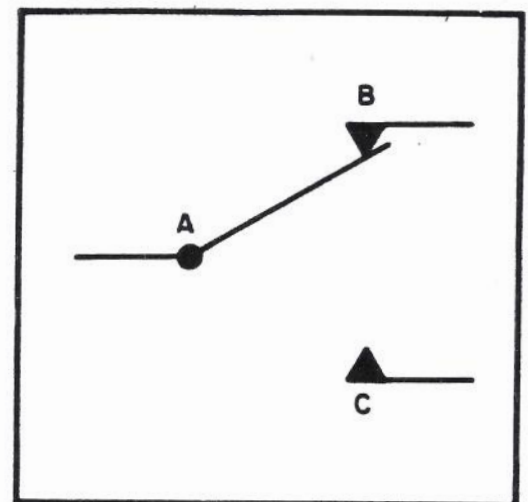

9. The mediums normally used in condensing refrigerants are

- A) air and vapor
- B) air and water
- C) vapor and gas
- D) liquid and vapor
- E) water and gas

10. Which of the following test equipment would most likely be used in determining amplifier band width?

- A) ammeter
- B) wattage meter
- C) tube tester
- D) frequency analyzer
- E) sweep generator

11. Most air conditioners with motors of 1 horsepower operate on which type of source?

- A) 220 volt, three phase
- B) 110 volt, single phase
- C) 220 volt, two phase
- D) 110 volt, two phase
- E) none of the above

12. In a shipment of pumps, 26 were defective. This is 40 percent of the total number of pumps ordered. What was the total number of pumps ordered?

- A) 48
- B) 56
- C) 38
- D) 81
- E) 65

Correct answers for questions 1 through 12

- | | | | | | |
|------|------|------|-------|-------|-------|
| 1. A | 2. D | 3. B | 4. C | 5. A | 6. E |
| 7. D | 8. C | 9. B | 10. D | 11. B | 12. E |

Part II

In addition to studying the information below, we suggest that you obtain books and material on basic mechanics, basic electricity and basic electronics. These types of books may be obtained from your local library. This will best prepare you for the actual exam.

1. What is the total net capacitance of two 60 farad capacitors connected in series?

- A) 30 farads
- B) 90 farads
- C) 120 farads
- D) 60 farads
- E) 360 farads

2. Select the Boolean equation that matches the circuit diagram in Figure 5-3 (shown below).

- A) $Z = A+B+C+D+E+F$
- B) $Z = AB+CD+EF$
- C) $Z = (A+B) (C+D) (E+F)$
- D) $Z = ABCD (E+F)$

3. In pure binary the decimal number 6 would be expressed as:

- A) 111
- B) 001
- C) 011
- D) 110

Figure 5-3

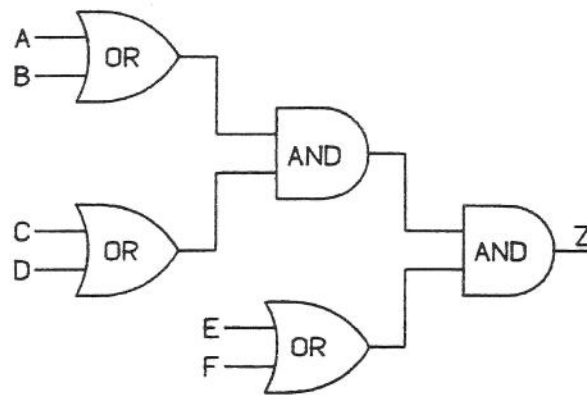

4. In Figure 5-4 (shown below), which of the following scores will be printed?

- A) All scores > 90 and < 60
- B) All scores ≤ 90 and ≥ 60
- C) All scores < 90
- D) All scores < 60

Figure 5-4

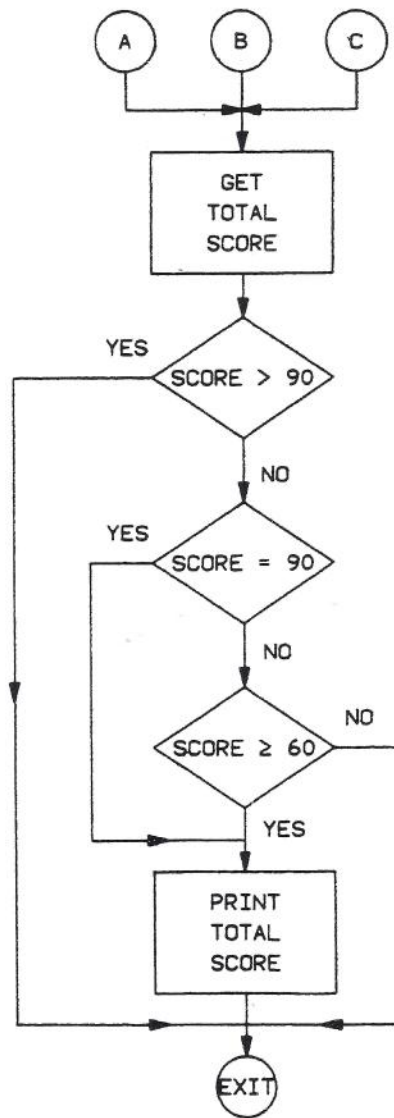

Correct answers for Part II questions 1 through 4

1. A

2. C

3. D

4. B

Part III

This section is a Two Part exam. Part A is *Following Oral Instructions* and Part B is a *Multiple Choice Test*.

In addition to studying this section below, we suggest that you obtain books and material on basic mechanics, basic electricity and basic electronics. These types of books may be obtained from your local library. This will best prepare you for the actual exam.

Part A

In Part A of the test, you will be told to follow directions by writing in a test booklet and then on an answer sheet. The test booklet will have lines of material like the following five samples:

SAMPLE 1. 5__

SAMPLE 2. 1 6 4 3 7

SAMPLE 3. D B A E C

SAMPLE 4. (8__)(5__)(2__)(9__)(10__)

SAMPLE 5. (7__) [6__] (1__) [12__]

To practice this test, have someone read the instructions on the next page to you and you follow the instructions. When they tell you to darken the space on the sample answer sheet, use the one at the bottom of this page.

Sample Answer Grid

1	(A)(B)(C)(D)(E)	4	(A)(B)(C)(D)(E)	7	(A)(B)(C)(D)(E)	10	(A)(B)(C)(D)(E)
2	(A)(B)(C)(D)(E)	5	(A)(B)(C)(D)(E)	8	(A)(B)(C)(D)(E)	11	(A)(B)(C)(D)(E)
3	(A)(B)(C)(D)(E)	6	(A)(B)(C)(D)(E)	9	(A)(B)(C)(D)(E)	12	(A)(B)(C)(D)(E)

Instructions to be read (the words in parentheses should not be read aloud).

You are to follow the instructions that I shall read to you. I cannot repeat them.

Look at the samples. Sample 1 has a number and a line beside it. On the line write an A. (Pause 2 seconds.) Now on the Sample Answer Sheet, find number 5 (pause 2 seconds) and darken the space for the letter you just wrote on the line. (Pause 2 seconds.)

Look at Sample 2. (Pause slightly.) Draw a line under the third number. (Pause 2 seconds.) Now look on the Sample Answer Sheet, find the number under which you just drew a line and darken space B as in baker for that number. (Pause 5 seconds.)

Look at Sample 3. (Pause slightly.) Draw a line under the third letter in the line. (Pause 2 seconds.) Now on your Sample Answer Sheet, find number 9 (Pause 2 seconds.) and darken the space for the letter under which you drew a line. (Pause 5 seconds.)

Look at the five circles in Sample 4. (Pause slightly.) Each circle has a number and a line in it. Write D as in dog on the blank in the last circle. (Pause 2 seconds.) Now on the Sample Answer Sheet, darken the space for the number-letter combination that is in the circle you just wrote in. (Pause 5 seconds.)

Look at Sample 5. (Pause slightly.) There are two circles and two boxes of different sizes with numbers in them. (Pause slightly.) If 4 is more than 2 and if 5 is less than 3, write A in the smaller circle. (Pause slightly.) Otherwise write C in the larger box. (Pause 2 seconds.) Now on the Sample Answer Sheet, darken the space for the number-letter combination in the circle or box in which you just wrote. (Pause 5 seconds.)

CORRECT ANSWERS

Now look at the Sample Answer Sheet. (Pause slightly.) You should have darkened spaces 4B, 5A, 9A, 10D and 12C on the Sample Answer Sheet. (If the person preparing to take the exam made any mistakes, try to help him or her understand why the mistakes are wrong.)

Part B

1. Which device is used to transfer power and rotary mechanical motion from one shaft to another?
 - A) Bearing
 - B) Lever
 - C) Idler roller
 - D) Gear
 - E) Bushing

2. If two 30 mH inductors are connected in series, what is the total net inductance of the combination?
- A) 15 mH
 - B) 20 mH
 - C) 30 mH
 - D) 45 mH
 - E) 60 mH
3. What special care is required in the storage of hard steel roller bearings? They should be
- A) cleaned and spun dry with compressed air
 - B) oiled once a month
 - C) stored in a humid place
 - D) wrapped in oiled paper
 - E) stored at temperatures below 90 degrees Fahrenheit
4. A circuit has two resistors of equal value in series. The voltage and current in the circuit are 20 volts and 2 amps respectively. What is the value of EACH resistor?
- A) 5 ohms
 - B) 10 ohms
 - C) 15 ohms
 - D) 20 ohms
 - E) not enough information given
5. Which is the correct tool for tightening or loosening a water pipe?
- A) slip joint pliers
 - B) household pliers
 - C) monkey wrench
 - D) water pump pliers
 - E) pipe wrench

6. Which instrument is used to test insulation breakdown of a conductor?

- A) ohmmeter
- B) ammeter
- C) megger
- D) wheatstone bridge
- E) voltmeter

7. Which is most appropriate for pulling a heavy load?

- A) electric lift
- B) fork lift
- C) tow conveyer
- D) dolly
- E) pallet truck

8. What unit of measurement is read on a dial torque wrench?

- A) pounds
- B) inches
- C) centimeters
- D) foot-pounds
- E) degrees

9. The primary purpose of soldering is to

- A) melt solder to a molten state
- B) heat metal parts to the right temperature to be joined
- C) join metal parts by melting the parts
- D) harden metal
- E) join metal parts

10. $2.6 - .5 =$

- A) 2.0
- B) 2.1
- C) 3.1
- D) 3.3
- E) None of the above

11. A small crane was used to raise the heavy part. Raise means:

- A) lift
- B) drag
- C) drop
- D) deliver
- E) guide

12. For sample question 12 below, select from the drawings of objects on the right labeled A, B, C and D, the one that would have the TOP, FRONT and RIGHT views shown in the drawing at the left

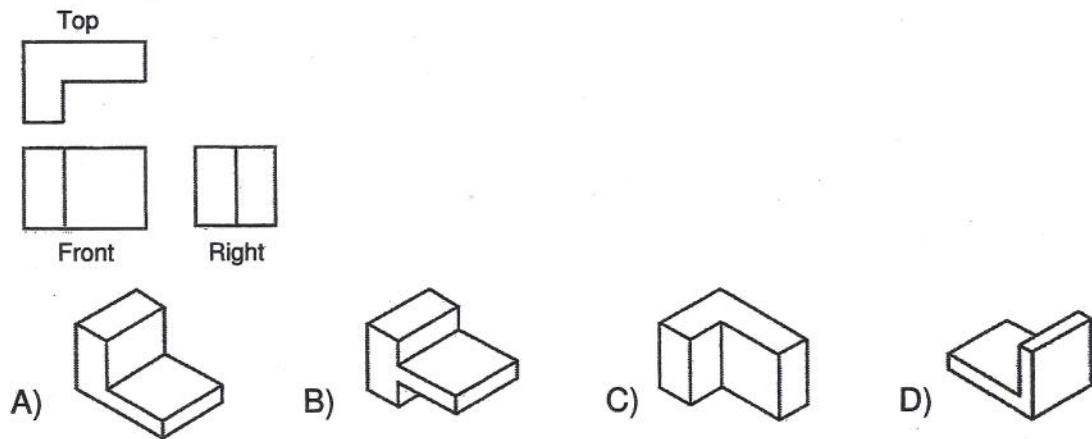

Correct Answers for Part B questions 1 through 12

1. D 2. E 3. D 4. A 5. E 6. C 7. E 8. D 9. E 10. B 11. A 12. C